

PL-520

S
ST

PIONEER®

OPERATING INSTRUCTIONS

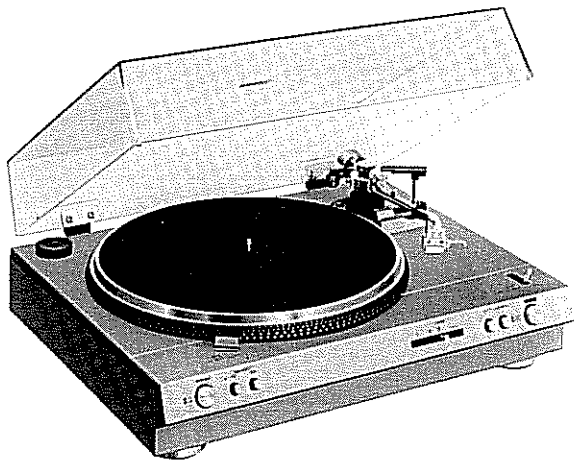

This turntable is available in two models: one with a Pioneer phono cartridge, and the other without a phono cartridge. The performance and functions are the same. These OPERATING INSTRUCTIONS are based on the former PL-520.

PL-520 FEATURES

Brushless DC Servomotor with Hall Elements

The PL-520 incorporates a high-precision phonomotor combining control circuitry composed of semiconductors with Hall elements in the brushless DC motor. The speed of the platter is smooth since the Hall elements guarantee accurate position detection and the motor's winding current is controlled by transistors. Another feature is the high inertia platter. Altogether, these attractive features make for a signal-to-noise ratio of more than 73dB (DIN-B) and a wow and flutter of less than 0.03% (WRMS).

Two-motor, Full-automatic Turntable with Precision Geared Motor Mechanisms

The lead-in and return of the tonearm are performed by a special precision geared motor mechanism which does not affect the speed of the platter at all. Furthermore, a speed detection-type auto-return mechanism controls the tonearm for accurate and stable operation every time it is returned to the arm rest.

Switches and Controls are Located at the Front for Easy Operation

The two-speed fine-adjustment knobs for adjusting the speed of the platter, the push-button speed selector switch, the size selector for selecting the size of the records, the stop button, repeat button and start button are all located on the front panel. This means that you don't have to lift the dust cover every time you want to make an adjustment. It also means that it is much easier to use this turntable on a shelf or audio rack.

High-sensitivity Tonearm with Excellent Trackability

The newly developed, high-sensitivity S-shaped tonearm comes with built-in lateral balance and anti-skating mechanisms and it displays excellent tracking performance with a light tracking force cartridge. There is a separate tracking force weight in front so that you can easily change the tracking force even if you have mounted your turntable in an audio rack.

Wide Selection of Accessory Mechanisms

There is a plentiful variety of accessory mechanisms including an independent arm-elevation mechanism, a headshell stand for conveniently storing a spare cartridge, a free stop-hinged dust cover which allows easy attachment and removal, and large-sized insulator feet.

CONTENTS

PL-520 Features	1
Line Voltage Selector Switch	2
Attaching the Cartridge	2
Assembly Procedure	3
Adjusting the Tonearm	4
Dust Cover	5
Stereo Amplifier Connections	5
Panel Facilities	6
Operation	8
Adjusting Stylus Descent Position	10
General Precautions	10
Troubleshooting	11
Specifications	12

LINE VOLTAGE SELECTOR SWITCH

This turntable is equipped with a line voltage selector switch which allows this turntable to be used in locations where the power voltage is 110V, 120V, 220V or 240V.

Before your turntable is shipped from the factory, the switch is set to the power requirements of the turntable's destination, although you should check that it is set properly before plugging the power cord into the outlet. If the voltage is not properly set or if you move to an area where the voltage requirements differ, adjust the selector switch as follows:

1. Disconnect the power cord.
2. Provide yourself with a medium-sized screwdriver. Insert the tip of the screwdriver into the groove of the selector switch and turn it to the voltage indication corresponding to the power voltage of your residence. You can tell when it clicks into place.

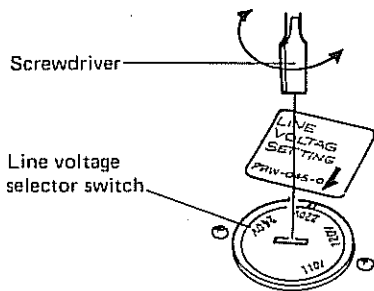

Fig. 1

ATTACHING THE CARTRIDGE

You can attach any cartridge to this turntable as long as it weighs between 4g and 10g. Follow the procedure outlined below for attaching the cartridge.

1. Take out the headshell, cartridge mounting screws, nuts, washers and small-sized screwdriver from the accessory box. The screws come in three different lengths so choose the screws according to the height of the cartridge you intend to attach.
2. The terminals on the accessory headshell are aligned as shown in Fig. 2. Check the location and polarity of each of the cartridge's terminal pins and then connect the lead wires, taking care not to get the polarities mixed up.

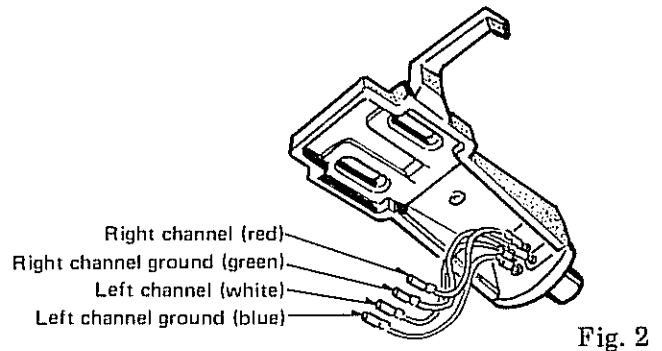

Fig. 2

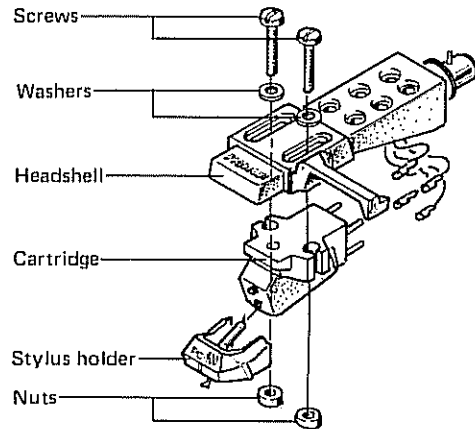

Fig. 3

NOTE:

Do not solder when you connect the lead wires to the cartridge. If the lead wire lugs are loose, use a pair of tweezers or a similar device to push in the end lightly.

3. Attach the cartridge lightly to the headshell using the screws, nuts and washers (Fig. 3).
4. Adjust the position of the cartridge so that the stylus and the connector section of the headshell are 49mm apart and tighten up the screws. Make sure that the cartridge does not tilt to one side when you attach it (see Fig. 4).

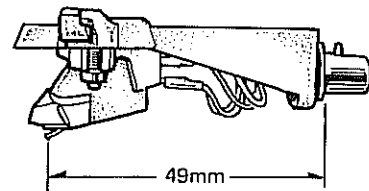
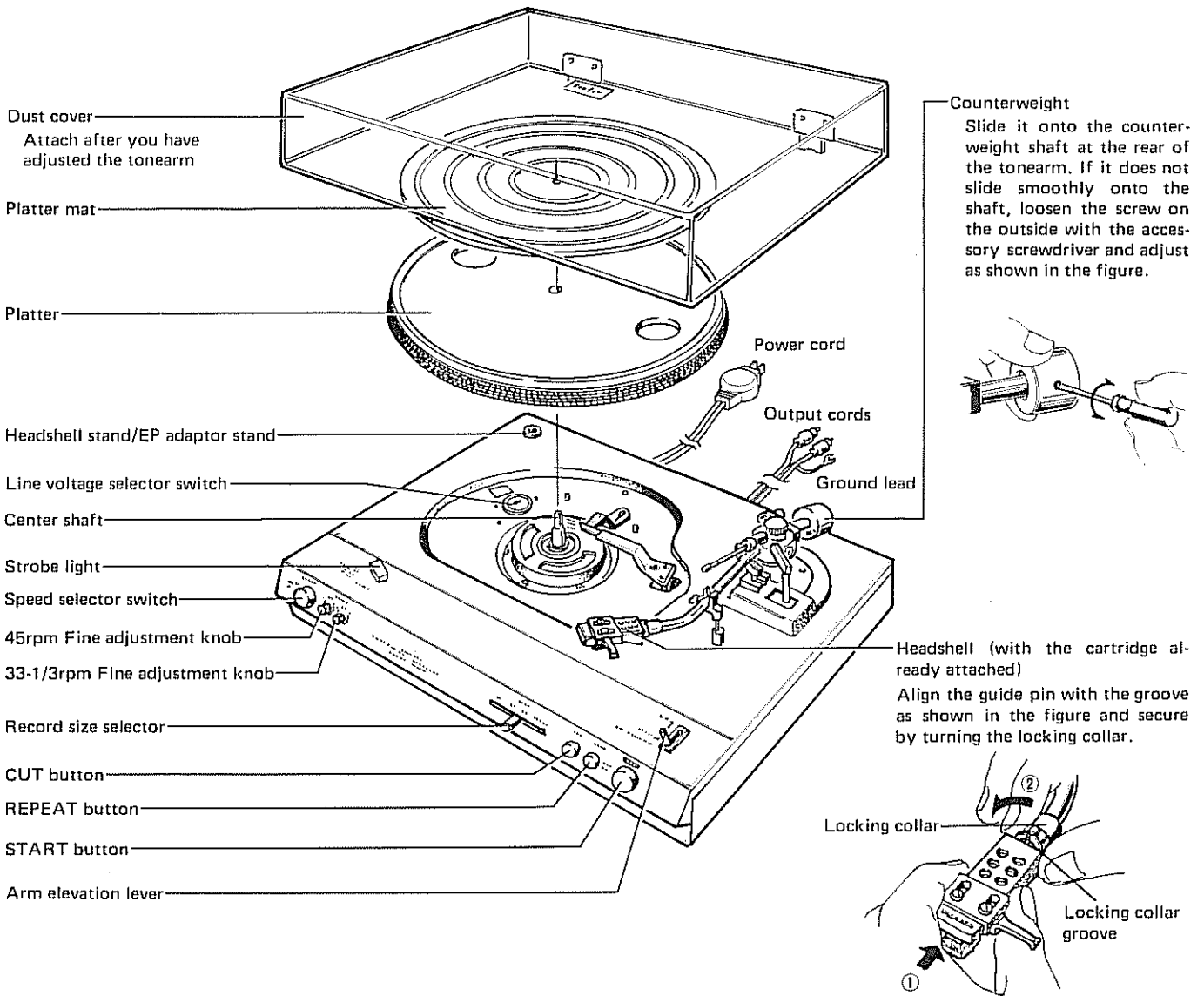

Fig. 4

ATTACHING HEADSHELLS NOT MADE BY PIONEER

You can attach headshells made by other companies as long as the coupling portion has the same dimensions as the headshell supplied with your PL-520. However, you should check whether the terminals on the other headshell are aligned in the same way. When attaching, make sure that you do not neglect to carry out the four steps described above.

ASSEMBLY PROCEDURE



INSTALLATION PRECAUTIONS

When installing your PL-520, make sure that you avoid the following conditions:

Conditions to be avoided	Possible problems caused
(1) Exposure to direct sunlight, high temperatures or high humidity.	(1) Can cause rust or interfere with insulation.
(2) Unstable surfaces.	(2) Will interfere with normal operation of turntable (stylus will jump, etc.)
(3) Dirty or dusty locations.	(3) Can cause scratches.
(4) Exposure to heavy vibrations, such as on the top of speakers, etc.	(4) Can cause howl.
(5) Proximity to power transformer of the amplifier.	(5) Can cause hum.
(6) Locations where alcohol, insecticides, or inflammable substances are frequently used.	(6) Can corrode dust cover or outside of cabinet.

ADJUSTING THE TONEARM

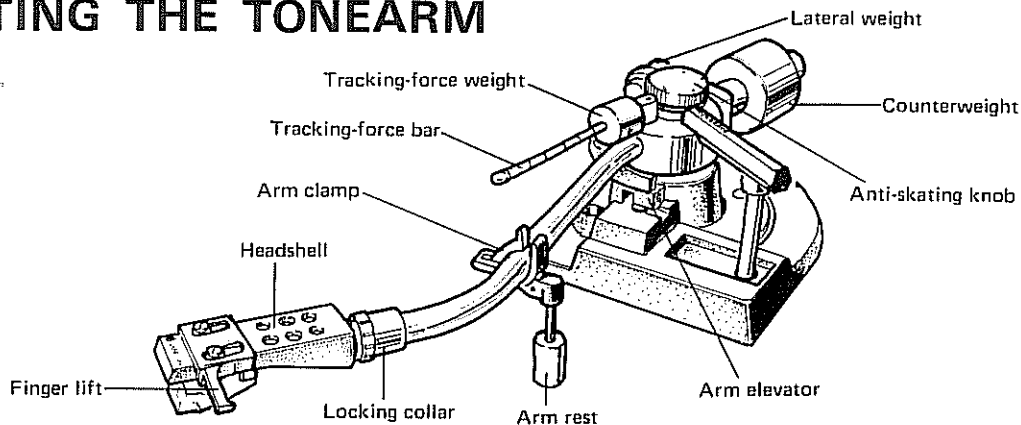

Fig. 5

RELEASING THE AUTO MECHANISM

Before adjusting the tonearm, release the auto mechanism as follows:

1. Plug the power cord into an AC outlet.
2. Set the size selector to MANUAL.
3. Push the START button.
4. About 10 seconds after the platter has started to rotate, the arm elevator will descend. Then, disconnect the power cord from the AC outlet. Do NOT press the CUT button. This operation releases the auto mechanism and the tonearm can now be operated as you wish.

LEVEL BALANCE ADJUSTMENT

1. Slide the tracking-force weight down to the base of the tracking-force bar (Fig. 6).

NOTE:

If the weight does not slide along smoothly, loosen the screw on the outside with the accessory screwdriver so that it can be shifted smoothly.

2. Turn the anti-skating knob counterclockwise and set to '0' (Fig. 6).

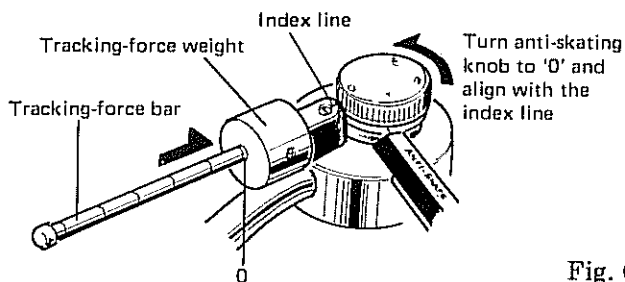

Fig. 6

3. Remove the cartridge stylus cover.
4. Release the arm clamp and move the tonearm to the space between the arm rest and the platter, taking care not to damage the stylus.
5. Support the headshell's finger lift with one hand and attain the level balance by moving the counterweight either forward or backward. Level balance means that the tonearm is parallel

to the record on the platter, and that the tonearm pipe, therefore, should not tilt toward the counterweight side or the headshell side (See Fig. 7).

6. Return the tonearm to the arm rest and fasten the arm clamp.
7. Attach the stylus cover to protect the stylus.

NOTE:

If the level balance of the tonearm is not properly attained, the stylus will be lowered onto the record at an angle. This will cause distortion when you play a record and it may damage the record and stylus. Make sure that you have attained the level balance properly by referring to Fig. 7.

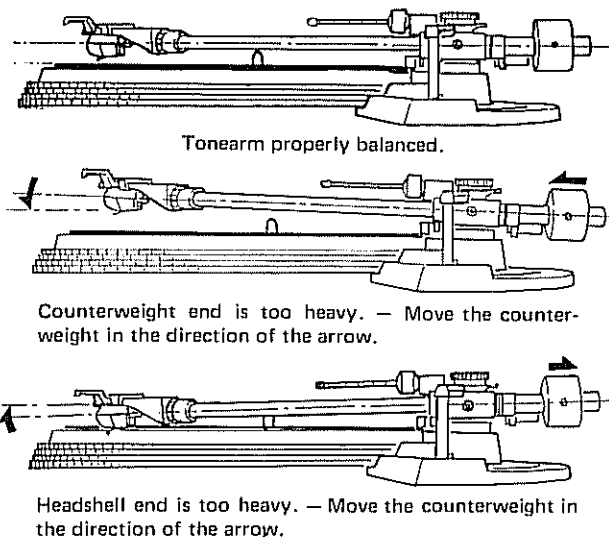

Fig. 7

TRACKING FORCE ADJUSTMENT

The tracking-force scale ring on the tracking-force bar has 0.5g steps. Slide the tracking-force weight along the bar and when the end of the weight is aligned with one of the lines indicated in Fig. 8, then a tracking force equivalent to the value indicated will be applied to the cartridge.

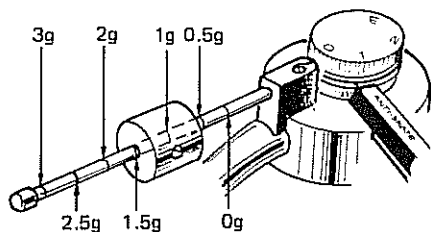

Fig. 8

The cartridge that comes with the PL-520 has a tracking force of 1.5 grams. Slide the tracking-force weight along the bar so that the end of the weight is aligned with the 1.5g line.

ANTI-SKATING ADJUSTMENT

Turn the anti-skating knob on the tonearm shaft clockwise and adjust one of the numbers indicated on the knob to the index line so that the corresponding tracking force is applied.

NOTE:

When turning the anti-skating knob, always clamp the tonearm to the arm rest first.

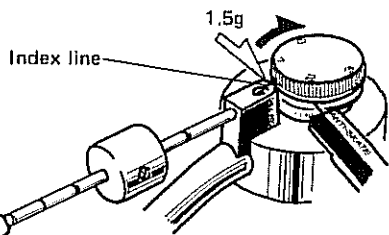

This figure shows the anti-skating adjustment when the tracking force is about 1.5g.

Fig. 9

DUST COVER

Attach the dust cover by inserting the hinges into the fittings on the rear panel of the cabinet. When attaching the dust cover, hold the lower part of the dust cover from behind the turntable as shown in Fig. 10, and it will slide smoothly into place. To remove the dust cover, first open it all the way, hold it firmly at the bottom as shown in the figure, and lift it straight up.

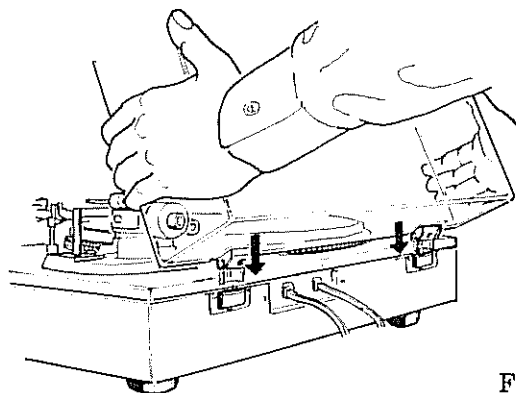

Fig. 10

STEREO AMPLIFIER CONNECTIONS

The PL-520's phono cables and ground lead are attached to the rear panel of the turntable. The phono cable with the white plug is for the left channel and the one with the red plug is for the right channel. The thin wire with the Y-shaped connector at the end is the ground lead. This should be firmly connected to the ground terminal on the amplifier (Fig. 11).

The way in which the phono cables are attached will depend on the type of cartridge used. Read the instructions in the booklet that comes with the cartridge as well as the operating instructions of the amplifier and connect the phono cables properly.

Finally, plug the power cord into the power outlet. If this is carried out after the tonearm has been adjusted, the platter will start to rotate. Push the CUT button and stop the platter. The auto-play mechanism is now set to stand-by.

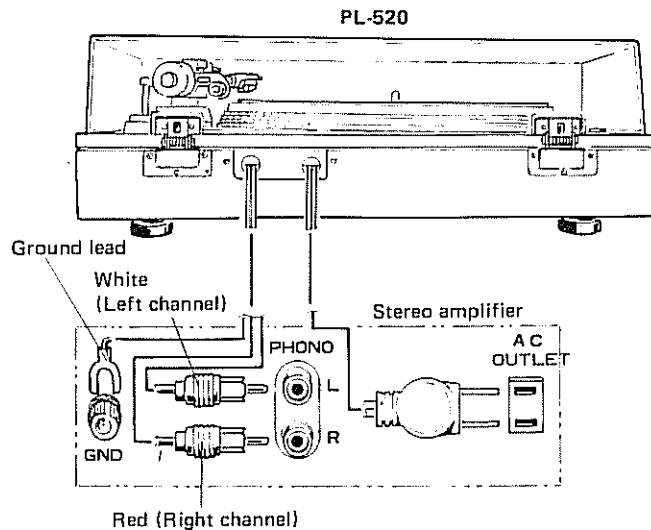

Fig. 11

With the PL-520 (the model with the accessory cartridge), plug the phono cables into the PHONO or PHONO MAG jacks of the stereo amplifier.

PANEL FACILITIES

HEADSHELL STAND/EP ADAPTOR STAND

This stand will accommodate a spare cartridge. Align the guide pin with the guide groove of the stand's opening, and then insert. You can also use this stand to store an EP adaptor.

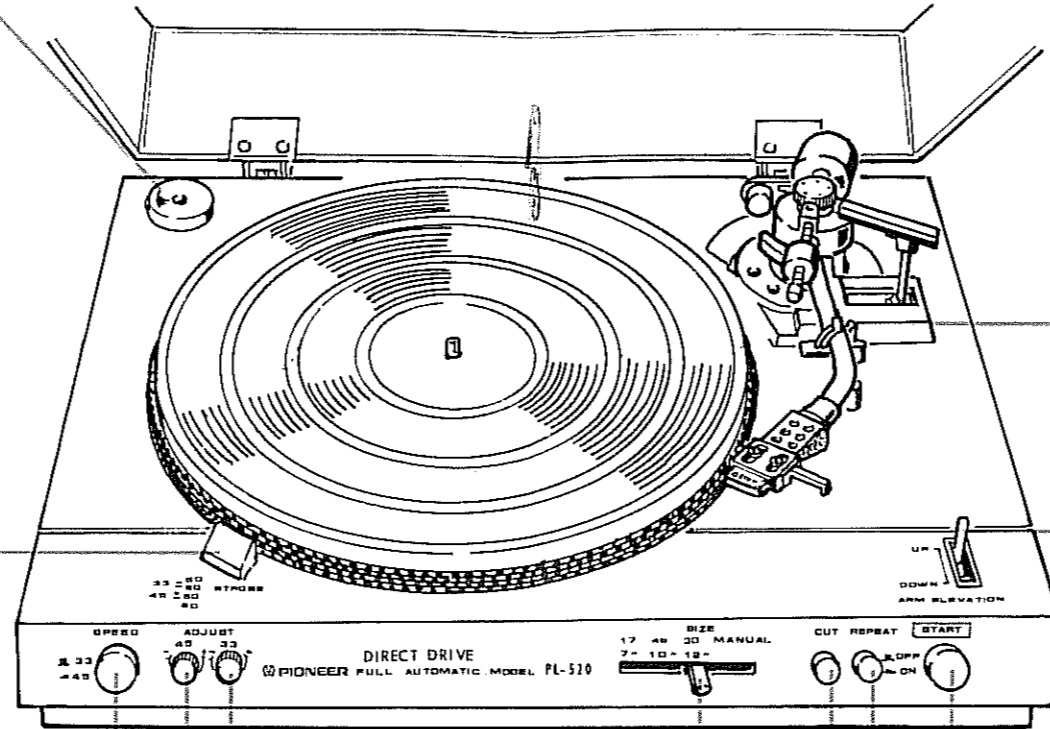
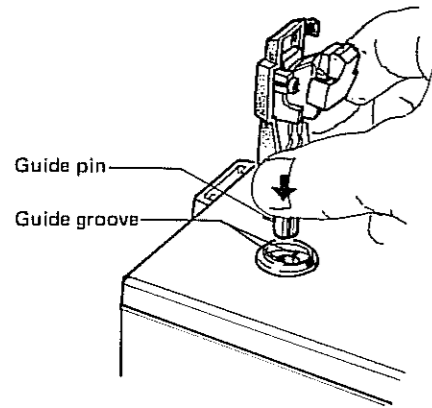

ARM REST

The arm rest supports the tonearm when it is not being used. Set the tonearm on its rest when it is not playing records. Clamp it into position if you don't have any immediate plans to play records (see Figure).

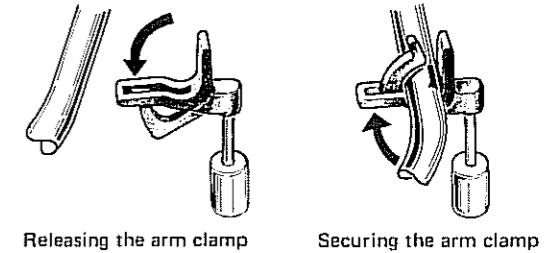

STROBE LIGHT

This light comes on when the platter starts to rotate and it lights stroboscopically. (Refer to 'How to finely adjust the platter speed' on page 8).

ARM ELEVATION LEVER

This lever controls the ascent and descent of the tonearm.
 UP The tonearm rises.
 DOWN The tonearm descends gently.
 Set to this position for auto play, auto repeat and other automatic operations.

NOTE:
 When the arm elevation lever is set to the UP position for automatic play, the tonearm will move over as far as the lead-in groove on the record but it will not descend and the record will therefore not be played.

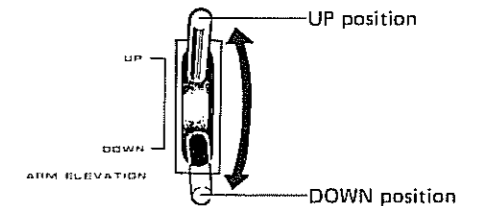

SPEED SELECTOR SWITCH

Push this switch to set the platter to 45rpm and release for 33-1/3rpm.

45rpm FINE ADJUSTMENT KNOB

When the platter speed is set to 45rpm, turn this knob and adjust the speed accurately, while looking at the strip of strobe calibration dots on the platter edge. The speed increases if the switch is turned in the + direction, and it decreases when turned in the - direction. (Refer to 'How to finely adjust the platter speed').

RECORD SIZE SELECTOR

- This selector selects the size of the record for automatic play and also selects manual play.
- 17 7" For the automatic play of 17cm (7-inch) LP and EP records.
 - 25 10" For the automatic play of 25cm (10-inch) LP records.
 - 30 12" For the automatic play of 30cm (12-inch) LP records.
 - MANUAL For the manual play of records.

NOTE:
 The tonearm will not be actuated when the record size selector is at the MANUAL position for automatic play, even if the START button and the REPEAT button are pushed.

CUT BUTTON

Push this button to stop the record play. When pushed, the tonearm will rise and return to the arm rest. The power to the turntable will then be switched off and a few seconds later, the platter will stop rotating.

NOTE:
 If the REPEAT button is pushed, the tonearm will return to the arm rest and then move across again to the record.

START BUTTON

The power to the turntable is turned on and the platter starts to rotate when this button is depressed.

REPEAT BUTTON

Push this button when you want to listen to the same record again. Press the button once more to release.

NOTE:
 All you have to do for repeat play is to press the REPEAT button. There is no need to push the START button again.

33-1/3rpm FINE ADJUSTMENT KNOB

When the platter speed is set to 33-1/3rpm, turn this knob and adjust the speed accurately, while looking at the strip of strobe calibration dots on the platter edge. The speed increases if the switch is turned in the + direction, and it decreases when turned in the - direction. (Refer to 'How to finely adjust the platter speed').

OPERATION

HOW TO FINELY ADJUST THE PLATTER SPEED

Finely adjust the platter speed as follows:

1. Set the record size selector to the MANUAL position.
2. Set the speed selector switch to 33.
3. Push the START button and observe the appropriate strip of strobe calibration dots on the platter edge (Fig. 12).
4. If the strobe dots appear to flow to the right (which means that the platter is rotating more slowly than the rated speed), turn the 33-1/3rpm fine adjustment knob in the + direction and set so that the strobe dots no longer appear to move.
5. If the strobe dots appear to flow to the left (which means that the platter is rotating more quickly than the rated speed), turn the 33-1/3 rpm fine adjustment knob in the - direction and set so that the strobe dots no longer appear to move.
5. Set the speed selector switch to 45, and proceed to adjust in exactly the same way with the 45rpm fine adjustment knob, while observing the appropriate strip of strobe calibration dots on the platter edge (Fig. 12).

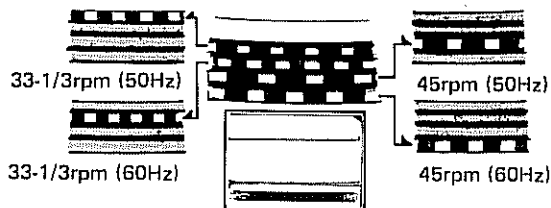

Fig. 12

AUTOMATIC PLAY

1. First, place the record on the platter.
 2. Set the speed selector switch to the speed at which the record is to be played.
 3. Set the arm elevation lever to the DOWN position.
 4. Set the record size selector in accordance with the size of the record on the platter.
 5. Remove the stylus cover and release the arm clamp.
 6. Press the START button slowly (until you hear the sound of the start mechanism being actuated). The strobe light comes on and the platter rotates.
- When the platter rotates, the tonearm moves, the stylus tip settles down gently into the lead-in groove of the record, and play begins.
7. Adjust the volume and tone controls on the amplifier to the preferred levels, and then sit back and enjoy your record.
 8. After the record has been played, the auto-return mechanism is actuated and the tonearm returns to the arm rest. At the same time, the power to the turntable is turned off, and the platter comes to rest a few seconds later.
 9. Secure the tonearm to the arm rest with the clamp and attach the stylus cover to protect the stylus.

MANUAL PLAY

1. Place the record on the platter.
2. Set the speed selector switch to the speed at which the record is to be played.
3. Set the arm elevation lever to the UP position.
4. Set the record size selector to the MANUAL position.
5. Remove the stylus cover and release the arm clamp.
6. Press the START button slowly (until you hear the sound of the start mechanism being actuated). The strobe light comes on and the platter rotates.
7. Hold the headshell by the finger lift and move the stylus across the record to the track you want played.
8. Set the arm elevation lever to the DOWN position. The stylus will descend slowly to the record and play will begin.
9. Adjust the volume and tone controls on the amplifier to the preferred levels, and then sit back and enjoy your record.

10. After the record has been played, the auto return mechanism is actuated and the tonearm returns to the arm rest. At the same time, the power to the turntable is turned off, and the platter comes to rest a few seconds later.
11. Secure the tonearm to the arm rest with the clamp and attach the stylus cover to protect the stylus.

REPEAT PLAY

1. Place the record on the platter.
2. Set the speed selector switch to the speed at which the record is to be played.
3. Set the arm elevation lever to the DOWN position.
4. Set the record size selector in accordance with the size of the record on the platter.
5. Remove the stylus cover and release the arm clamp.
6. Press the REPEAT button. The strobe light comes on and the platter rotates.

When the platter rotates, the tonearm moves, the stylus tip settles down gently into the lead-in groove of the record, and play begins.

7. Adjust the volume and tone controls on the amplifier to the preferred levels, and then sit back and enjoy your record.
8. After the record has been played, the auto-return mechanism is actuated, and the tonearm returns to the arm rest. A few seconds later the tonearm moves over to the record again, and play begins.

The turntable will remain in the repeat mode until the REPEAT button is released, which releases the turntable from the repeat mode.

STOPPING THE TURNTABLE DURING PLAY

Press the CUT button gently (until you hear the sound of the return mechanism being actuated). The stylus will rise slowly from the surface of the record and the tonearm will return to the arm rest. The power to the turntable is then turned off and the platter comes to rest a few seconds later.

NOTE:

If you push the CUT button during repeat play, the tonearm will return to the arm rest and back again to the record for repeat play.

INTERRUPTING RECORD PLAY

Set the arm elevation lever to the UP position. The arm elevation mechanism is independent of the auto mechanism and so the tonearm will ascend and descend irrespective of whether the turntable is set to auto play or to manual play. This is a convenient function since it allows you to choose just the tracks you want to hear from an LP.

RELEASING REPEAT-PLAY MECHANISM

The repeat mechanism only is released when you push the REPEAT button during repeat play and then take your finger off the button. The turntable is then set to the normal auto play mode.

OPERATION PRECAUTIONS

- Always set the record size selector before you push the START and REPEAT buttons when you want to set the turntable to the auto play or repeat play modes. This is because the stylus will not descend where you want it to descend if you change the setting of the record size selector while the tonearm is moving. You may also damage the stylus and the record.
- Always clean the stylus both before and after playing a record with a soft brush and try to make it a rule to clean the records with a good quality cleaner.
- When changing over the headshell, clamp the tonearm to the arm rest so that the tonearm shaft is not strained in any way.
- Be careful not to make the turntable vibrate while a record is playing since this can result in damage to the stylus and record.
- Do not force the tonearm closer than 40mm to the center shaft or away from the arm rest. If this distance is exceeded, you may damage the internal mechanisms and render automatic operation ineffective.
- Place only one record at a time on the platter. If two or more records are stacked on the platter, the stylus will not make proper contact with the grooves, and this will impair the quality of reproduction.
- Do not disconnect the power cord while the stylus is still in a record groove as this may result in damage to the stylus and record.

ADJUSTING STYLUS DESCENT POSITION

If the stylus does not descend onto the lead-in groove on the record during automatic play, adjust as follows:

1. Place a 30cm (12-inch) LP record on the platter.
2. Go through the operation for automatic play once (refer to page 8), and check the level and direction of the stylus' deviation from the norm.
3. Return the tonearm to the arm rest, and then turn and adjust the stylus descent-position adjusting screw using the accessory screwdriver (See Figs. 13 & 14).
 - When the stylus descends outside the lead-in groove, turn the adjusting screw clockwise.
 - When the stylus descends inside the lead-in groove, turn the adjusting screw counterclockwise.
 - Each half-turn of the adjusting screw moves the starting point about 6mm.

NOTE:

Be very careful not to damage the record and the stylus when you are adjusting the position of the stylus descent.

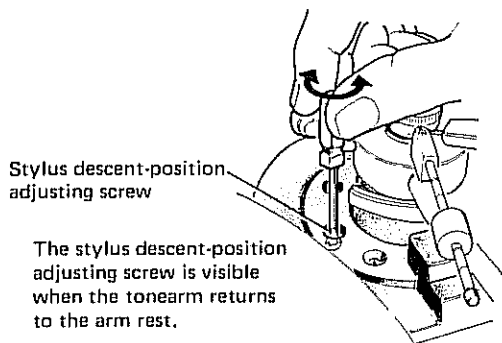
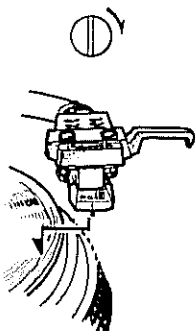

Fig. 13

Turn adjusting screw clockwise.



Turn adjusting screw counterclockwise.

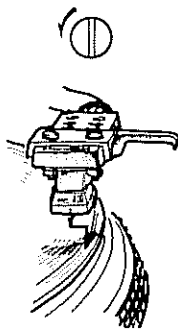

Fig. 14

GENERAL PRECAUTIONS

CABINET

When the dust cover or the cabinet is dirty or dusty, wipe them clean with a polishing cloth or soft cloth. Do not use furniture wax or bring the turntable into contact with benzine, insecticides or any other inflammable material since they will corrode the outside of the turntable.

MOTOR WORKS PROPERLY AFTER PLATTER IS MOUNTED

If the motor is run with the platter removed, the motor will not operate normally and may seem to have broken down. If, however, the platter is mounted, the motor will rotate properly.

LUBRICATION

There is no need to lubricate the PL-520 since it employs oil-less bearings in the rotating parts.

If the turntable is brought into the warm from previously cold surroundings, or if the room temperature rises suddenly, moisture will form on the operating sections and the turntable will not be able to display its performance to the full.

If confronted with a situation like this, leave the turntable in its new environment for about an hour or try and increase the room temperature gradually before operation.

TROUBLESHOOTING

Sometimes, an operational fault can be mistaken for a malfunction or failure. Check the following points and see if the symptoms of the trouble are outlined below before you get in touch with the serviceman. If you cannot locate the symptoms, contact your nearest Pioneer Service Center, Service Station or authorized Pioneer dealer.

Symptom	Possible trouble	Remedy
Platter does not rotate.	Power cord is unplugged.	Plug cord securely into wall outlet.
No sound	<ol style="list-style-type: none"> 1. Phono cables are not connected properly. 2. Headshell is not properly attached. 3. Cartridge lead wires are loose. 4. Amplifier is not being operated properly. (Function switch, tape monitor switch, speaker switches, etc. not set correctly). 	<ol style="list-style-type: none"> 1. Connect cables securely to the PHONO terminals on the amplifier (see page 5). 2. Firmly secure tonearm locking collar (see page 3). 3. Attach lead wires inside headshell properly (see page 2). 4. Read the operating instructions that come with amplifier.
Musical tempo is off.	<ol style="list-style-type: none"> 1. Platter speed is not set properly. 2. Strobe dots appear to move. 	<ol style="list-style-type: none"> 1. Refer to 'Panel Facilities' and their uses on page 6. 2. Refer to 'How to finely adjust the platter speed' on page 8.
Strobe dot movement cannot be stopped.	Speed fine adjustment knob not set properly in accordance with the platter speed.	Refer to 'How to finely adjust the platter speed' on page 8.
Excessive noise.	<ol style="list-style-type: none"> 1. Ground lead is not connected. 2. Tracking force is not correct. 3. Dust or dirt has collected on the stylus tip. 4. Dust or dirt has collected on the record. 	<ol style="list-style-type: none"> 1. Connect properly to the amplifier's ground terminal (see page 5). 2. Refer to tracking force adjustments on page 4. 3. Clean the stylus tip with a soft brush. 4. Clean the record with a good quality cleaner.
Sound is distorted.	<ol style="list-style-type: none"> 1. Dust or dirt has collected on the stylus tip. 2. Tracking force is not correct. 3. Stylus is worn. 4. Amplifier's tone controls set too high. 	<ol style="list-style-type: none"> 1. Clean the stylus tip with a soft brush. 2. Refer to tracking force adjustment on page 4. 3. Replace with new stylus. 4. Set tone controls to lower position.
Tonearm does not descend with auto play.	<ol style="list-style-type: none"> 1. Arm elevation lever is set to UP position. 2. Tracking force is not correct. 	<ol style="list-style-type: none"> 1. Set to DOWN position. 2. Refer to tracking force adjustment on page 4.
Tonearm does not move with auto play.	<ol style="list-style-type: none"> 1. Arm clamp is still fastened. 2. Record size selector is set to MANUAL position. 	<ol style="list-style-type: none"> 1. Release arm clamp. 2. Set selector in accordance with size of record on platter.
Intermittent sound.	<ol style="list-style-type: none"> 1. Tracking force is not correct. 2. Stylus is worn. 3. Record is scratched or warped. 	<ol style="list-style-type: none"> 1. Refer to tracking force adjustment on page 4. 2. Replace with new stylus. 3. Replace record.
Stylus does not descend to correct position with auto-play.	_____	See stylus descent-position adjustment on page 10.

If you detect any trouble when playing records, the fault may not lie with the turntable but with another hi-fi component. Be sure to check the amplifier, speaker systems, and any other electrical equipment which you are using in the vicinity of the turntable.

SPECIFICATIONS

Motor and Turntable

Drive System: Direct-drive turntable
 Motor: DC servomotor (8 pole 24 slot)
 Turntable Platter: 330mm diam. aluminum alloy die-cast
 Inertial Mass: 200kg-cm² (including platter mat)
 Speeds: 33-1/3 and 45rpm
 Speeds Control Range: ±2%
 Wow and Flutter: Less than 0.03% (WRMS)
 Signal-to-Noise Ratio: More than 73dB (DIN-B)
 (with Pioneer cartridge model PC-135)

Tonearm

Type: Static-balance type, S-shaped pipe arm
 Effective Arm Length: 221mm
 Overhang: 15.5mm
 Tracking Error: 0.525 deg./in, 0.21 deg./cm
 Usable Cartridge Weight: 4g (min.) to 10g (max.)

Other Features

Warren motor for automatic functions (auto lead-in, auto return, auto cut, auto repeat), Anti-skating force control, Lateral balancer, Cueing device, Strobe light, Detachable dust cover, Fine speed adjusters, Insulator feet, Plug-in type headshell

Miscellaneous

Power Requirements: AC 110V/120V/220V/240V~
 (switchable), 50/60Hz
 Power Consumption: 8W
 Dimensions: 460(W) x 395(D) x 171(H)mm
 18-1/8(W) x 15-9/16(D) x 6-3/4(H) in
 Weight: 8.5kg/18 lb 12 oz

Accessories

EP adaptor 1
 Screwdriver 1
 Cartridge mounting screws 6
 Cartridge mounting nuts 2
 Cartridge mounting washers 2
 Operating instructions 1

Accessory Cartridge Specifications

Type: Moving magnet type
 Stylus: 0.5mil diamond (PN-400)
 Output Voltage: 2.5mV (1kHz, 50mm/s Peak Velocity, LAT)
 Tracking Force: 1.0g to 1.8g (proper 1.5g)
 Frequency Response: 10 to 40,000Hz

NOTES:

- Specifications and design subject to possible modification without notice, due to improvements.
- The PL-520 (with the accessory cartridge) does not come with cartridge mounting screws, nuts or washers.

STYLUS REPLACEMENT

The life expectancy of the accessory cartridge stylus tip is 800 – 1000 hours. For the sake of maximum sound quality reproduction, we recommend replacement within the minimum time limit. The stylus tip is replaced by grasping the stylus holder and pulling it away from the body of the cartridge. The new stylus tip is then inserted by pushing it into the receptacle. The correct replacement tip is the PN-400. This may be obtained from your Pioneer dealer. Pioneer cannot guarantee performance or reliability if another type of stylus is employed.

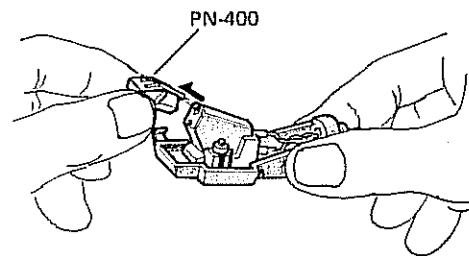

Fig. 15